

MFJ-1835H

10,12,15,17,20 METER

HIGH POWER
COBWEB ANTENNA

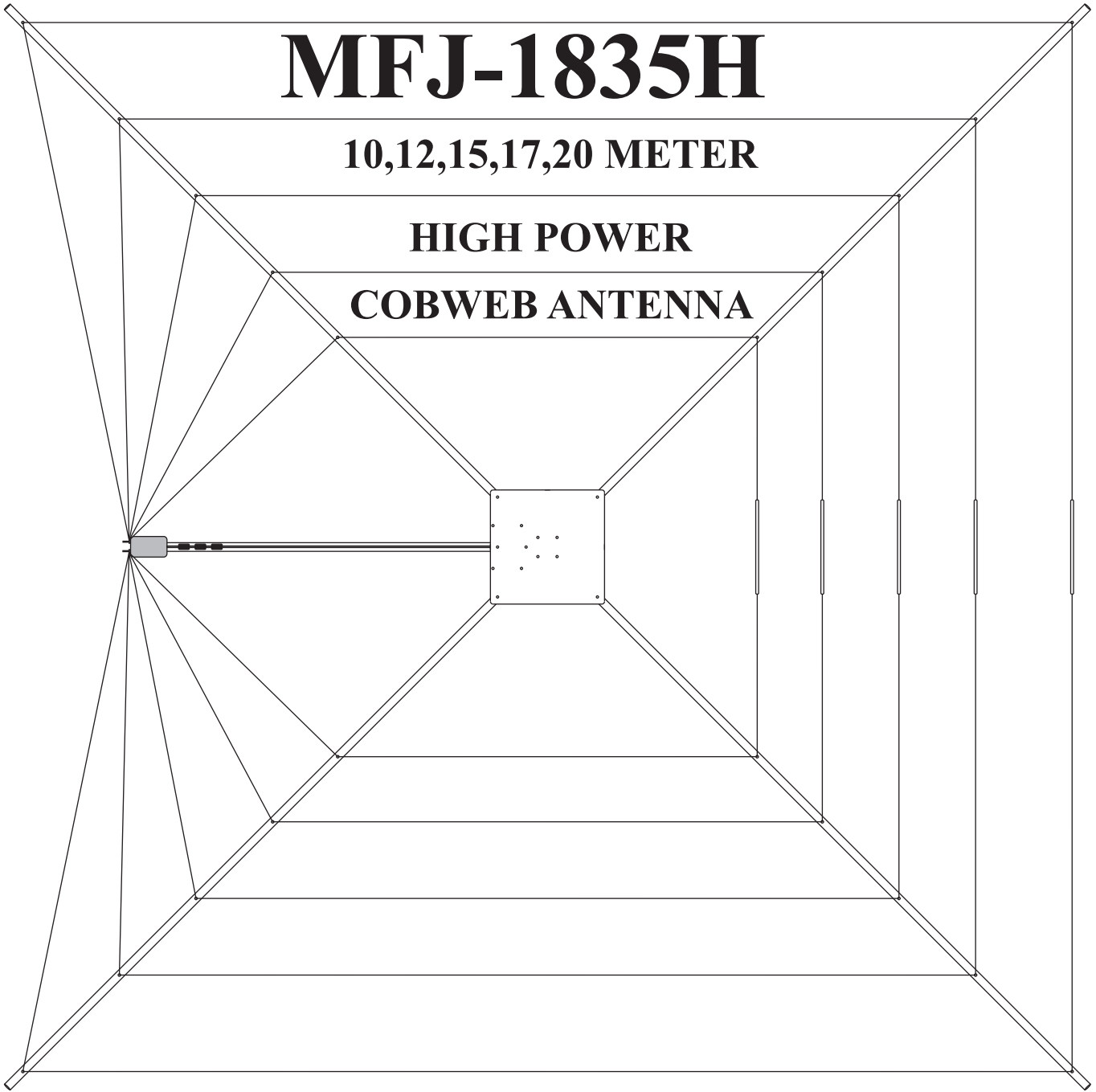

INSTRUCTION MANUAL

CAUTION: Read All Instructions
Before Operating Equipment

MFJ

300 Industrial Park Road
Starkville, MS 39759 USA
Tel: 662-323-5869 Fax: 662-323-6551

COPYRIGHT © 2015 MFJ Enterprises Inc.

Introduction

Thank you for purchasing the MFJ-1835H five band HF antenna. Your new antenna is composed of high strength material for excellent rigidity and light weight. The MFJ-1835H is compact and excellent for restricted space or portable installations. The antenna is omnidirectional enough to not require a rotator. It has good bandwidth and minimum SWR on all five bands. It can be mounted on tripod for temporary locations or any mast 1-1/2 diameter or smaller for permanent installation.

Preparation

This antenna although it is not heavy, might be cumbersome for one person to handle. It is a good idea to have a temporary mast about 6 feet off the ground to hold the antenna while you are working on it. If you don't have a mast available, saw horses or other support can be used. The antenna support arms can be installed on a flat surface like a garage floor if needed. The antenna assembly will go quickly and is fairly easy but take your time anyway. As with all antennas, safety glasses are recommended during the assembly and tuning. We don't want you to "Poke your eye out". Pick a clear open spot and assemble the antenna away from other people. Do not allow children in the assembly area. Only the people involved in the construction should be near. If you plan to assemble the antenna over grass, be prepared to go on a lawn safari to find the hardware that you drop. It's not a question of if, but when you drop something. A few extra parts have been included in the parts pack for just such an adventure. Assembly can be done by one person but when the antenna is to be mounted or moved, plan to have a friend help. It is not wise to attempt to install any antenna without help. Don't rush. The more time you put into the antenna, the happier you will be with the results.

WARNING

KEEP THIS ANTENNA
AWAY FROM POWER LINES

Never mount or move any antenna where it can come into contact with power lines. If this antenna comes into contact with power lines, it can KILL you. Never mount any antenna where if it fell it could come into contact with power lines.

In the box

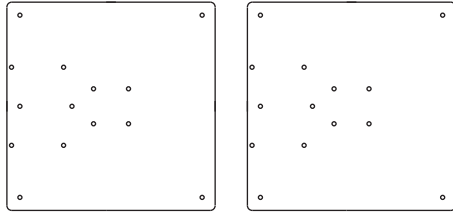

2 mounting plates

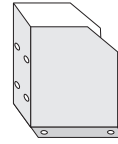

1 mounting bracket

4 element arms

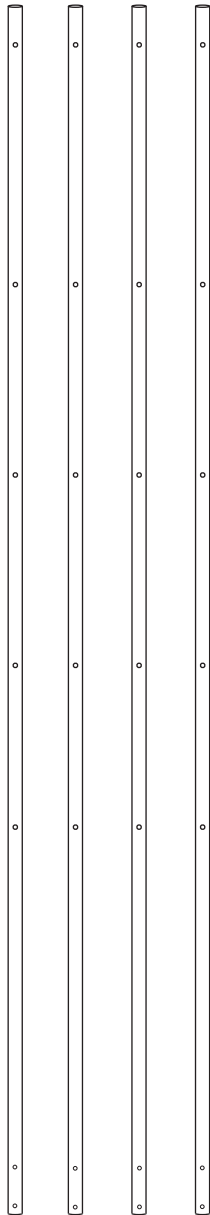

1 feed arm



5 insulators

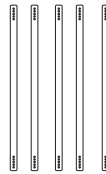

1 matching box



Parts pack

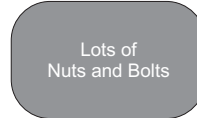

2 rolls of element wire for each band

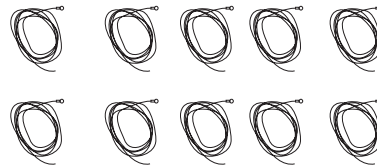

10 12 15 17 20

Assembly

Select one of the two mounting plates. Install the mount bracket onto the plate using four 6-32 x 1/2 screws and nuts. Make sure the nuts are on the bracket side

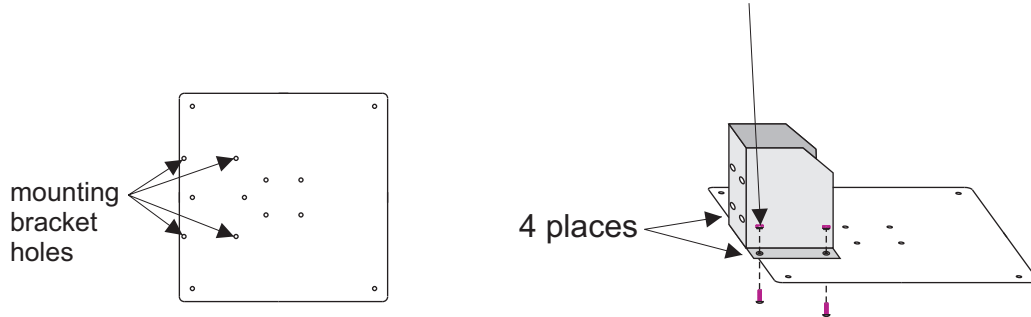

Support arms

Select one of the four element arms. Install the arm between the two plates using four 6-32 x 1 inch screws and nuts. Snug the nuts but do not tighten. Install the remaining three in the same manner.

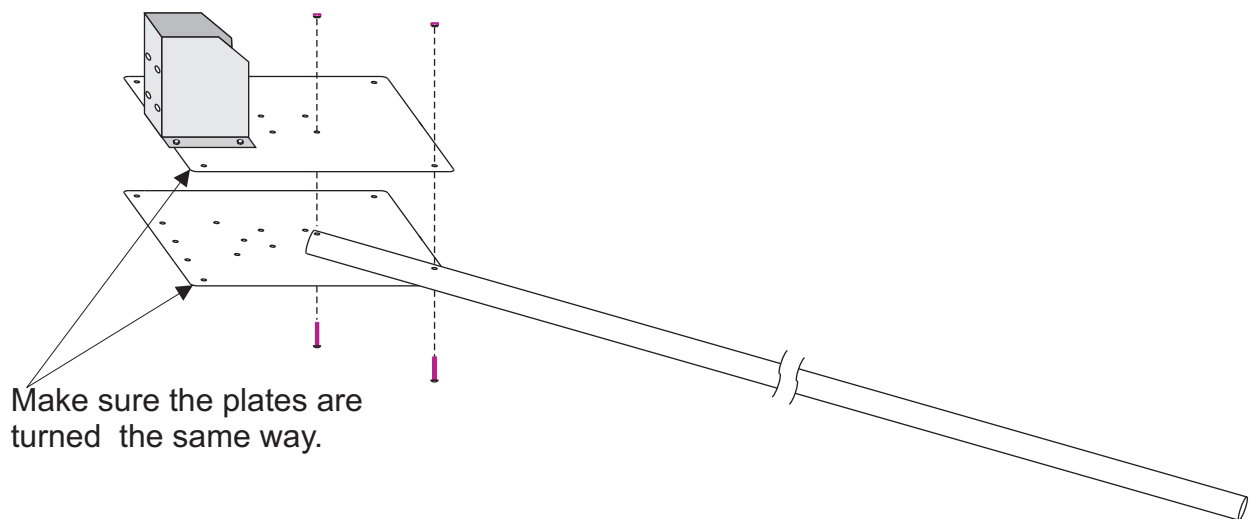

Feed tube

Install the feed tube using the last two holes in the plate. It does not matter which end you use. The hole patterns are the same. These holes are under the mounting bracket but it is not shown in this diagram.

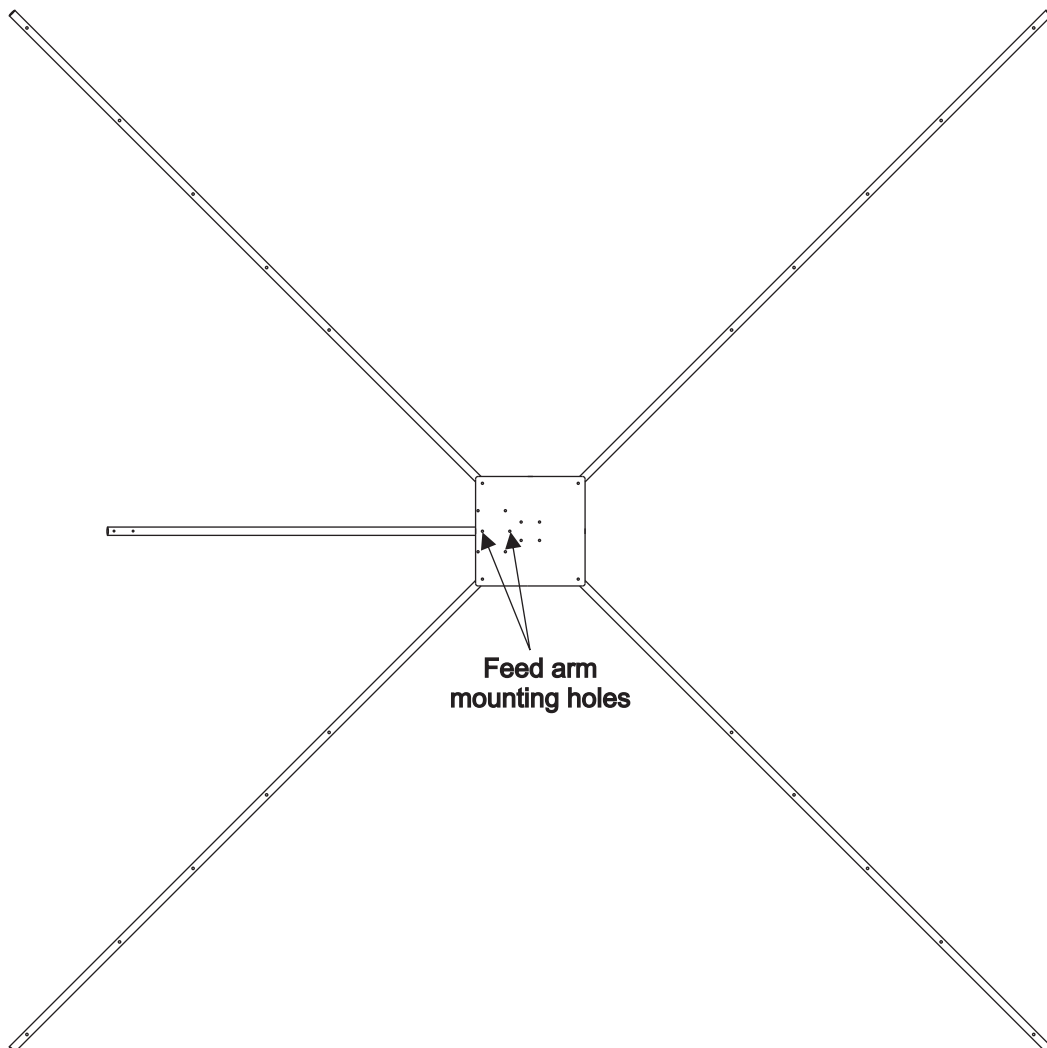

Matching box

The matching box can now be mounted to the feed arm. Use the hole closest to the end of the tube. The other hole will not be used. Use the 6-32 locking nut to secure it to the tube. Use the nylon ties to route the coax along the tube back towards the mounting plates. Wind 12 turns of coax with a six inch diameter or install equivalent balun

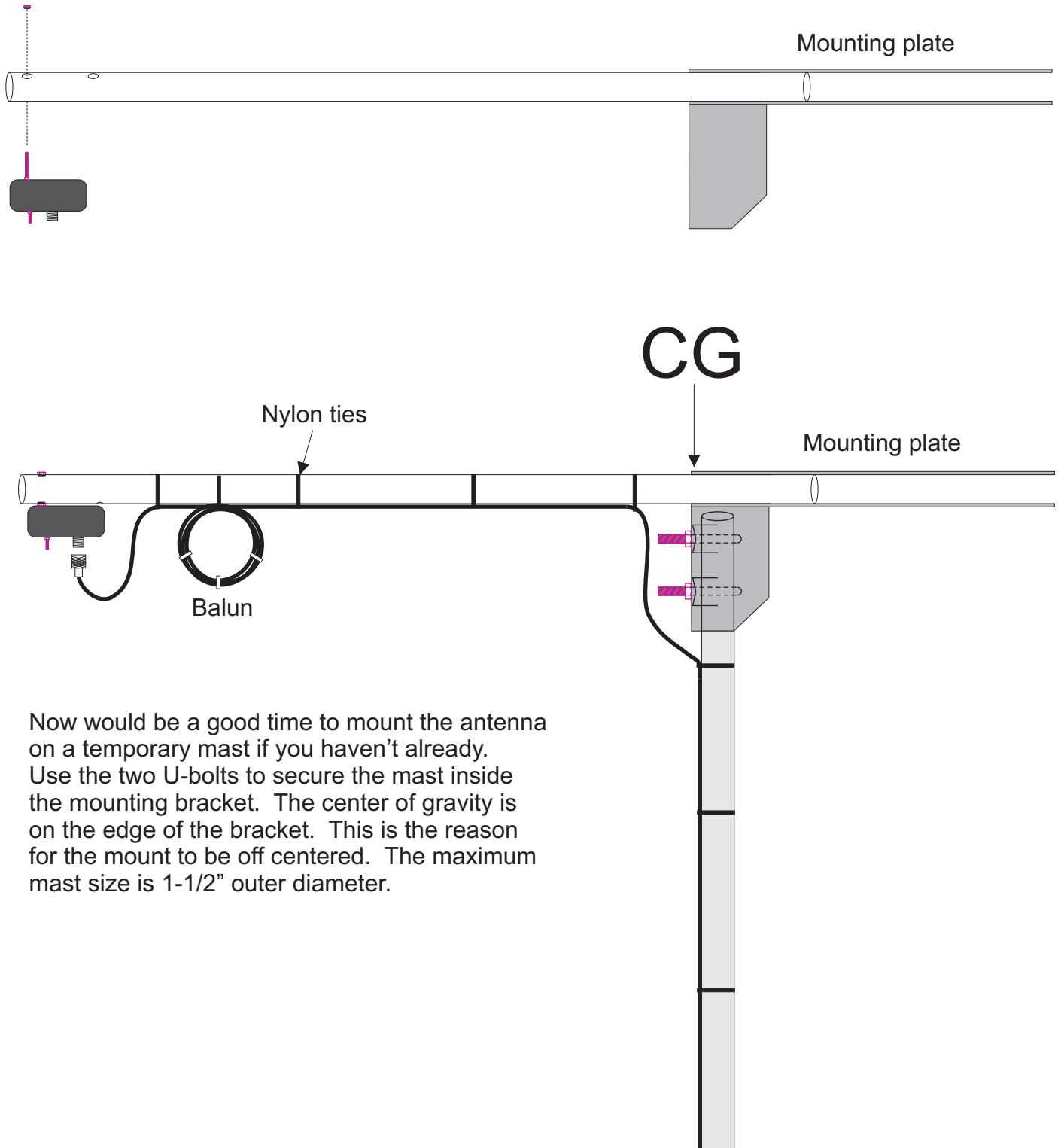

Now would be a good time to mount the antenna on a temporary mast if you haven't already. Use the two U-bolts to secure the mast inside the mounting bracket. The center of gravity is on the edge of the bracket. This is the reason for the mount to be off centered. The maximum mast size is 1-1/2" outer diameter.

Element Wires

Now it is time to route the element wires around the antenna. Start with the 10 meter wire on the inner most loop. The 10 meter wire will be the shortest one. Attach the end with the eyelet to one side of the balun box. Route the wire around the antenna to each of the inner most holes in the support arms. Insert a 1 inch screw with a flat washer on it through the fiberglass tube. Thread the nut onto the screw but do not tighten. Do this on at each hole as you add the wire. Do both sides and then attach the insulator. See figure below as to how to wrap the wire around the bolt on the insulator. Do this for both sides and try to make sure the insulator is centered. The same amount of wire should loop around each bolt. Pull the wire so that there is just a small amount of slack in the wire. Do not tighten the wire to remove sag. A little sag will not hurt the performance of the antenna and it will prevent stress to the element wire and support arms when icing or strong wind occurs.

Leave the screws with the washers on them loose to allow movement of the wire when installing the rest of the loops. Route the other loops the same way. Mind the tension of the wires on each element and try to keep them even. The insulators will naturally sag more than the other sections because of the added weight. This will not cause any problems with the operation of the antenna. When you are happy with how all the wires look, tighten the screws on the element tubes to prevent the wires from moving. Tighten the lock nuts on the matching box and compress the eyelets down for a good connection.

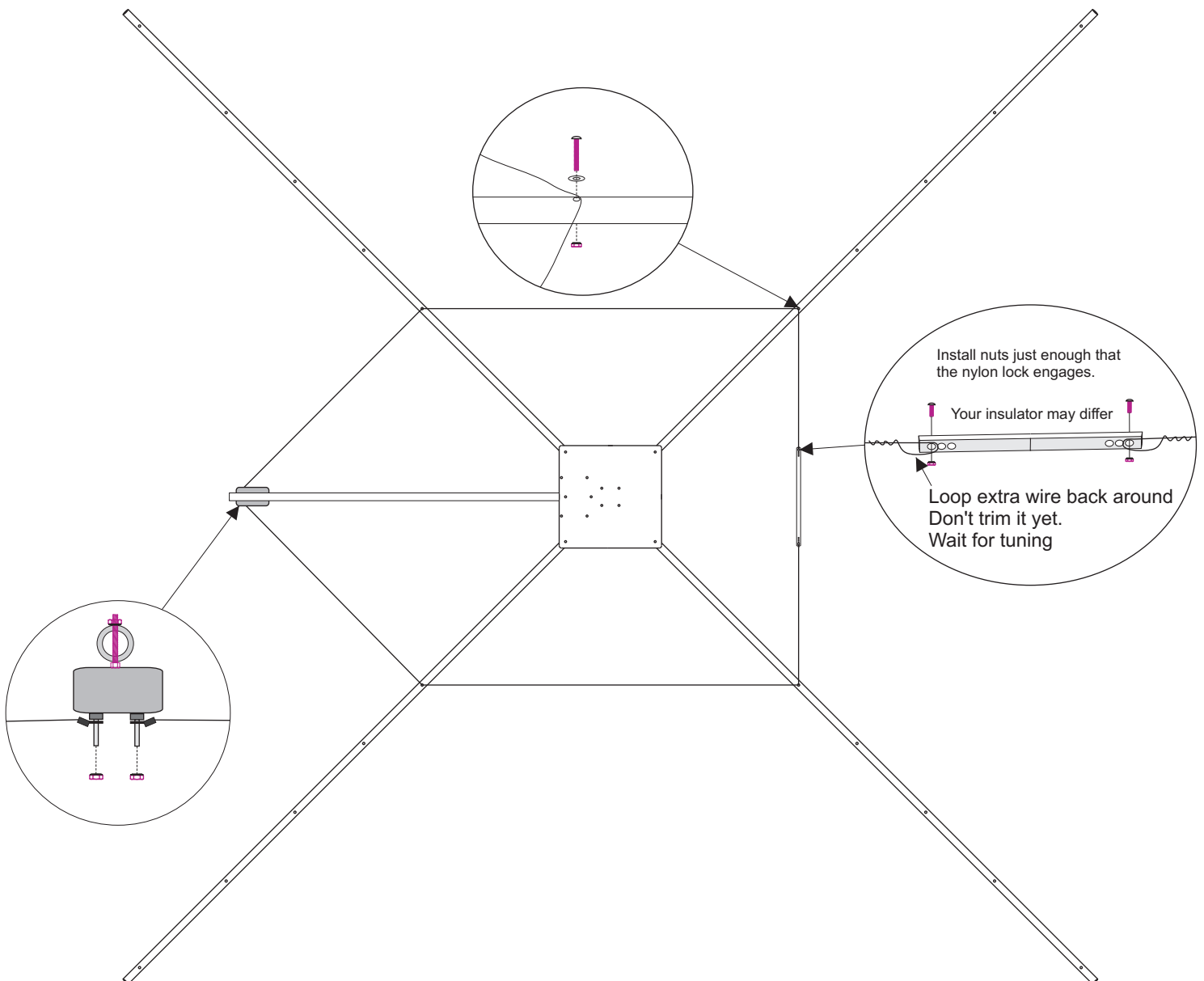

Tuning

The antenna should already be close the correct frequency for each band. Tuning strips have been included to adjust the frequency of operation for each band. Use an SWR analyzer or transceiver with an SWR meter to determine where the antenna is tuned to. The antenna should be at least 6 feet off the ground for any measurements to be close to final frequency when permanently mounted.

Adding the tuning strips to the ends of the wire will lower the operating frequency without changing the length of the wire. Both sides should be in the same hole location. Select the correct hole for the frequency you want.

EXAMPLE

This location will be the lowest frequency

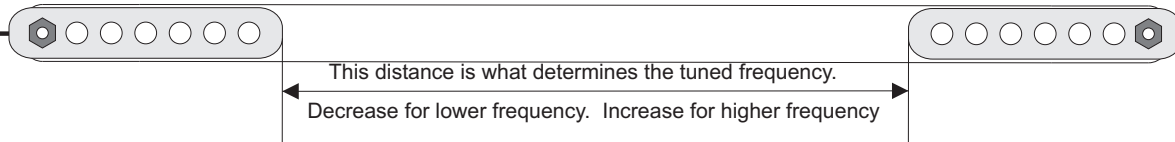

This location will be the highest frequency

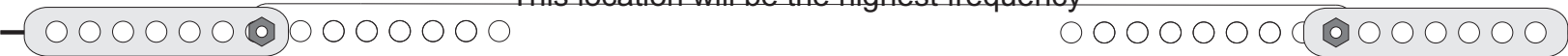

This location will be between the two



Remember that It is not necessary to add the strips if the antenna is already at the frequency you desire. You may move the ends of the wire to inner holes on the insulator if you need more length. The tuning will be dependent on location of the antenna and the tension on the wires.

Take your time tuning the antenna. Center each band at the location you most like to operate. Once you raise the antenna, check the tuning again to ensure that it has not changed. Objects surrounding the antenna in its final mounting location can cause the frequency to shift. If this is the case, it may take a few adjustments before you get it right.

Tuning option 2

Some customers have had success tuning the antenna wires simply by allowing excess wire to hang down from the insulators after looping around the bolts. Tuning adjustment is done by trimming the excess wire. The excess wire will cause the antenna to be tuned to a frequency below the band. Cutting the wire on each side evenly a little bit at a time, will raise the frequency. This might be easier for some and doesn't require the tuning strips which will cut down on the weight of the insulators. Note that there are extreme high voltages present at the tips of the wires and arcing may occur while transmitting if the wire is frayed. S

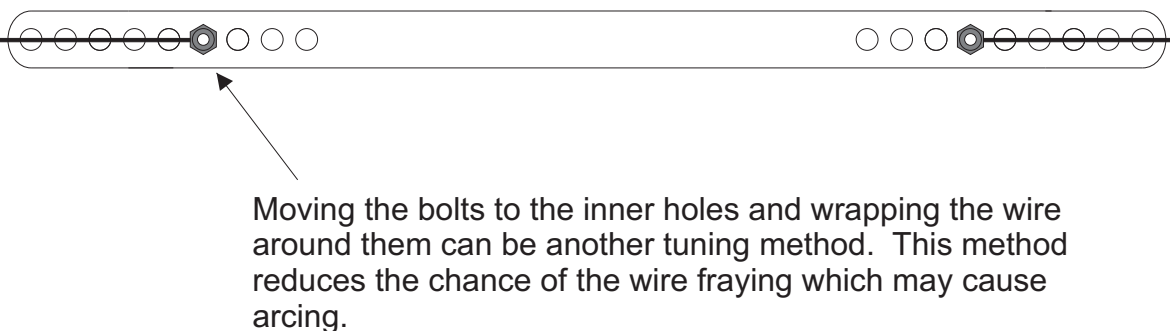
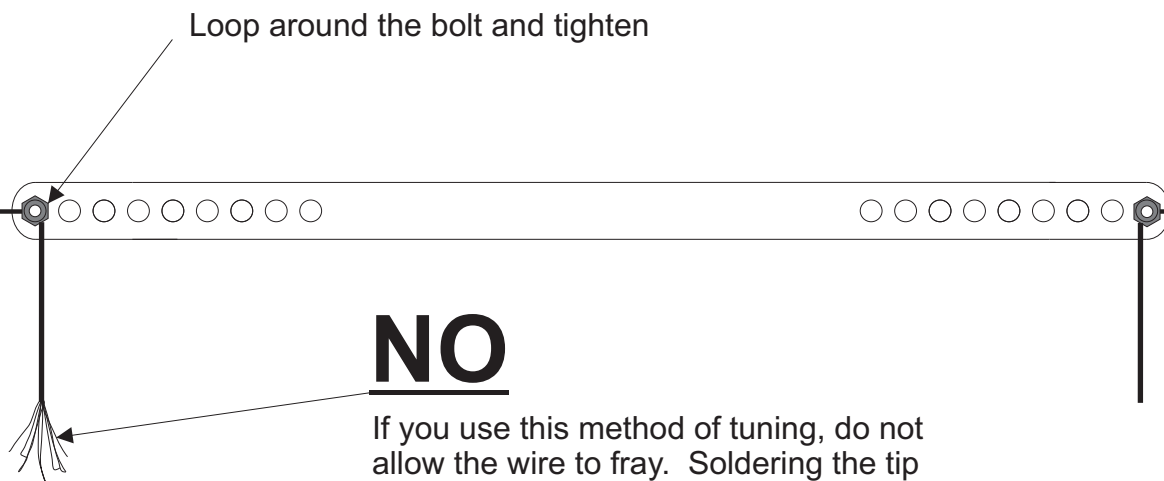

Antenna Mast

The recommended support mast for the MFJ-1835H is steel water pipe between the sizes of 1-1/2" OD to 1-1/4" OD and with a length that will place the antenna base at a safe height. The MFJ-1835H is designed to operate at a height of 10 or more feet for proper performance. Placement on the side of a house or garage at eaves level is acceptable as long as the wires will not be in contact with anything.

Antenna Grounding

Although the MFJ-1835H is designed to operate efficiently without the requirement of an earth ground, SAFETY GROUNDING must still be provided to protect equipment, property and persons from the hazards of lightning strikes and other weather related electrical discharges. In addition the coaxial cable feeding the antenna should have the shield grounded to eliminate the risk of any indoor equipment failure from allowing hazardous voltages from appearing indoors and creating a shock hazard. The support mast should be grounded with a large diameter ground wire.

Additional protection can be accomplished by grounding the shield of the coax where it enters the building to a good earth ground or directly burying the cable in the earth for several feet before it enters the building. The coaxial cable should be totally disconnected from the station during threatening weather conditions for maximum lightning protection.

Customer Supplied Components

- Quality low-loss 50 ohm coax cable with PL-259 connectors
- VSWR Analyzer (MFJ-259B or equiv.) or HF transceiver with VSWR meter
- Mounting mast with required hardware to provide sturdy support
- Balun to suppress feedline currents

PART #	DESCRIPTION	QTY
737-1835	8 x 8 aluminum plate	2
811-1835-1	72 inch fiberglass tube	4
811-1835-2	43 inch Fiberglass tube	1
10-1835H-1	Matching Box	1
735-1835	Mounting bracket	1
13-1835-10	10 meter wire assembly	2
13-1835-12	12 meter wire assembly	2
13-1835-15	15 meter wire assembly	2
13-1835-17	17 meter wire assembly	2
13-1835-20	20 meter wire assembly	2
737-0115	Insulator 12 x .5 inches.	5

Parts Pack 17-1835-1

656-1000S	6-32 X 1 inch screw	31
656-0375S	6-32 X 3/8 inch screw	14
705-0632-NL	6-32 Nut with nylon lock	47
561166	#6 Flat Washer	21
758-9199	U-Bolt assembly	2
745-2158B	Cable tie	5
737-1615	Adjusting strip	10

12 MONTH LIMITED WARRANTY

MFJ Enterprises, Inc. Warrants to the original owner of this product, if manufactured by MFJ Enterprises, Inc. and purchased from an authorized dealer or directly from MFJ Enterprises, Inc. to be free from defects in material and workmanship for a period of 12 months from date of purchase provided the following terms of this warranty are satisfied.

1. The purchaser must retain the dated proof-of-purchase (bill of sale, canceled check, credit card or money order receipt, etc.) describing the product to establish the validity of the warranty claim and submit the original or machine reproduction of such proof-of-purchase to MFJ Enterprises, Inc. at the time of warranty service. MFJ Enterprises, Inc. shall have the discretion to deny warranty without dated proof-of-purchase. Any evidence of alteration, erasure, or forgery shall be cause to void any and all warranty terms immediately.
2. MFJ Enterprises, Inc. agrees to repair or replace at MFJ's option without charge to the original owner any defective product under warranty, provided the product is returned postage prepaid to MFJ Enterprises, Inc. with a personal check, cashiers check, or money order for \$7.00 covering postage and handling.
3. MFJ Enterprises, Inc. will supply replacement parts free of charge for any MFJ product under warranty upon request. A dated proof-of-purchase and a \$5.00 personal check, cashiers check, or money order must be provided to cover postage and handling.
4. This warranty is NOT void for owners who attempt to repair defective units. Technical consultation is available by calling (662) 323-5869.
5. This warranty does not apply to kits sold by or manufactured by MFJ Enterprises, Inc.
6. Wired and tested PC board products are covered by this warranty provided only the wired and tested PC board product is returned. Wired and tested PC boards installed in the owner's cabinet or connected to switches, jacks, or cables, etc. sent to MFJ Enterprises, Inc. will be returned at the owner's expense unrepaired.
7. Under no circumstances is MFJ Enterprises, Inc. liable for consequential damages to person or property by the use of any MFJ products.
8. Out-of-warranty Service: MFJ Enterprises, Inc. will repair any out-of-warranty product provided the unit is shipped prepaid. All repaired units will be shipped COD to the owner. Repair charges will be added to the COD fee unless other arrangements are made.
9. This warranty is given in lieu of any other warranty expressed or implied.
10. MFJ Enterprises, Inc. reserves the right to make changes or improvements in design or manufacture without incurring any obligation to install such changes upon any of the products previously manufactured.
11. All MFJ products to be serviced in-warranty or out-of-warranty should be addressed to MFJ Enterprises, Inc., 300 Industrial Park Road, Starkville, Mississippi 39759, USA and must be accompanied by a letter describing the problem in detail along with a copy of your dated proof-of-purchase.
12. This warranty gives you specific rights, and you may also have other rights, which vary from state to state.